

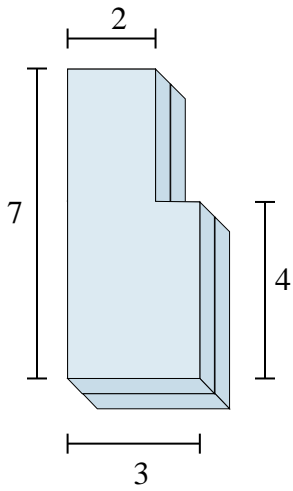

Bestimme das Gesamtvolumen jeder gezeigten Figur. Einheiten sind in cm und nicht maßstäblich.

Antworten

1)



2)

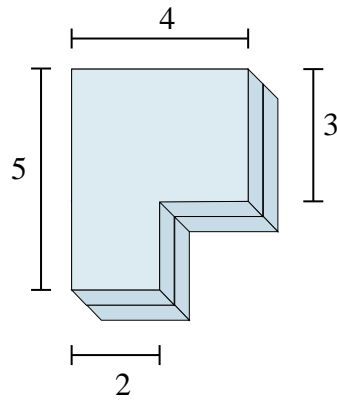

3)

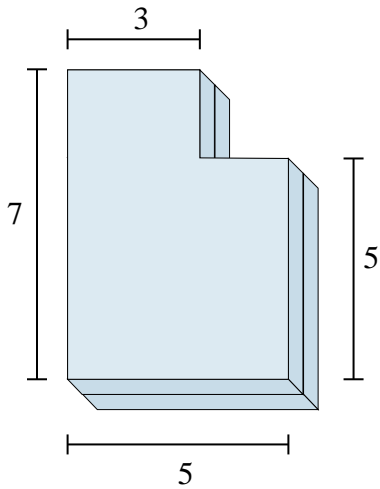

4)

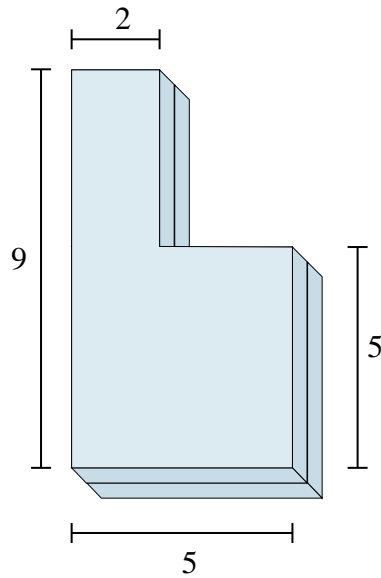

5)

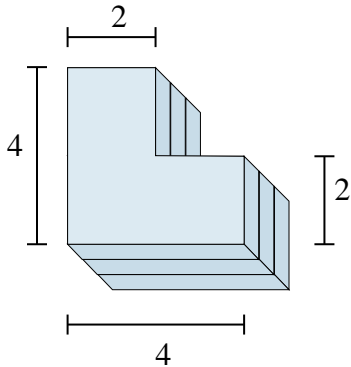

6)

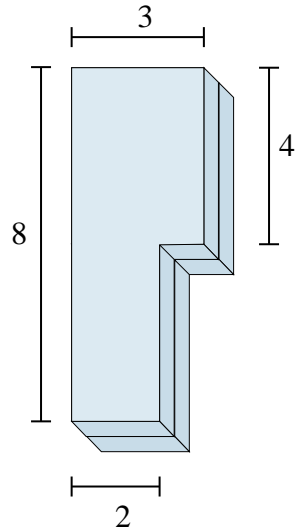

- 1. _____
- 2. _____
- 3. _____
- 4. _____
- 5. _____
- 6. _____



Bestimme das Gesamtvolumen jeder gezeigten Figur. Einheiten sind in cm und nicht maßstäblich.

1)

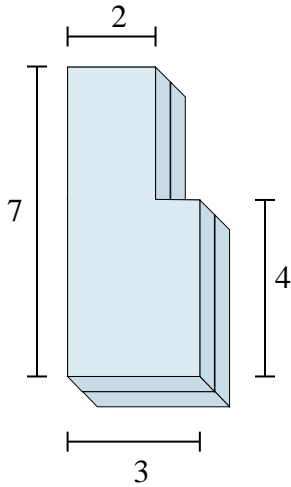

2)

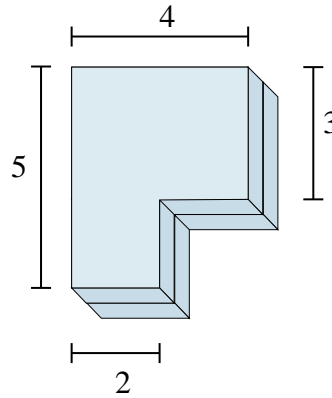

3)

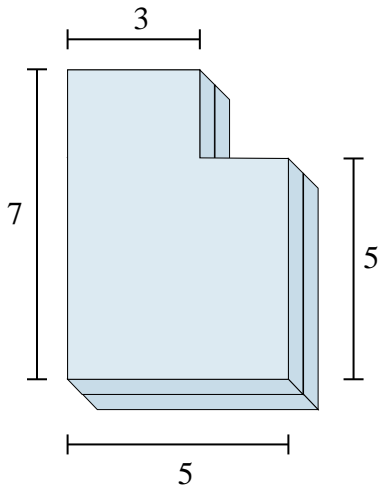

4)

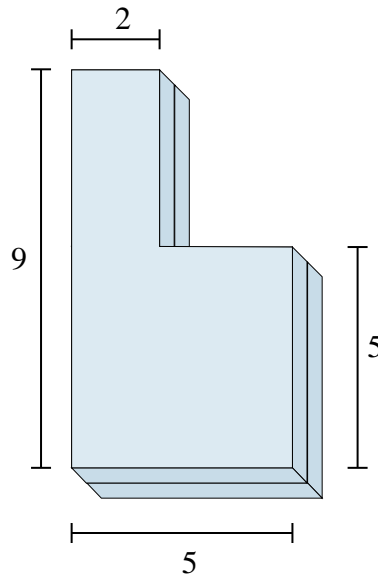

5)

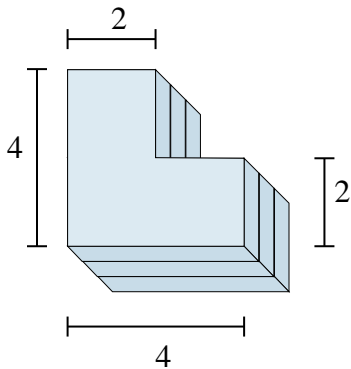

6)

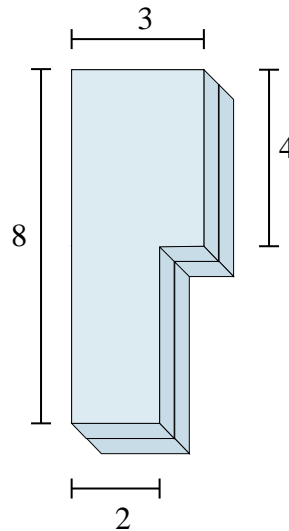
**Antworten**1. **36 cm³**2. **32 cm³**3. **62 cm³**4. **66 cm³**5. **36 cm³**6. **40 cm³**



Bestimme das Gesamtvolumen jeder gezeigten Figur. Einheiten sind in cm und nicht maßstäblich.

Antworten

1)

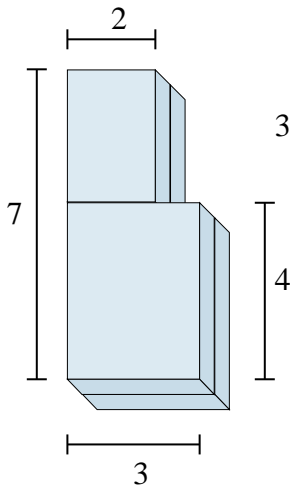

2)

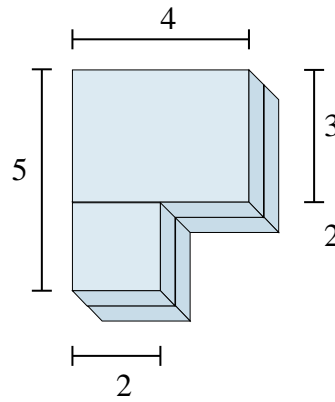

3)

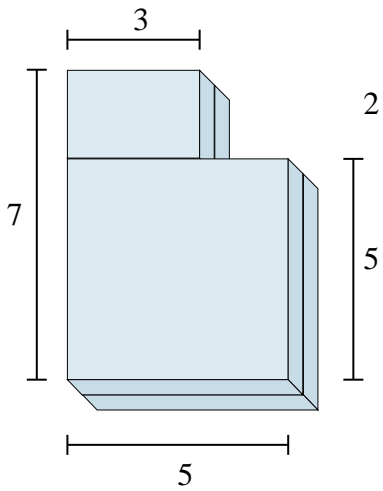

4)

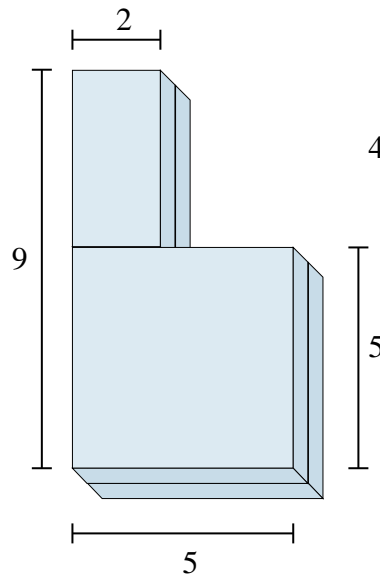

5)

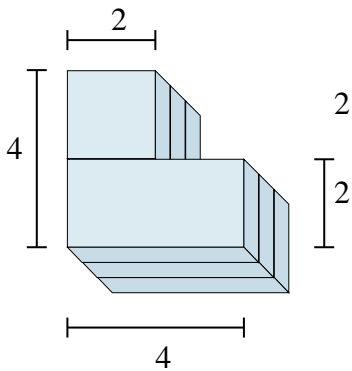

6)

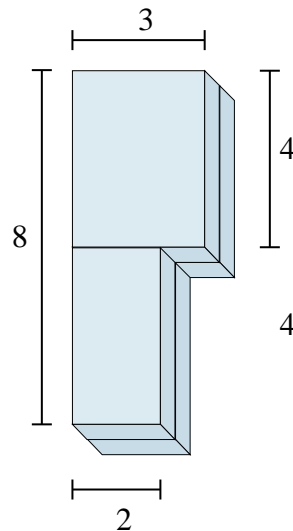

- 1. _____
- 2. _____
- 3. _____
- 4. _____
- 5. _____
- 6. _____